

1061

COLOURWAYS

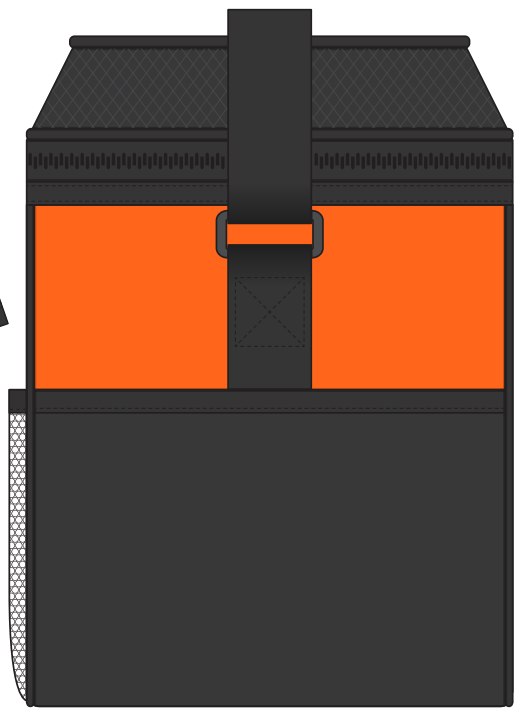

FRONT



RIGHT SIDE



BACK



LEFT SIDE

COLOUR

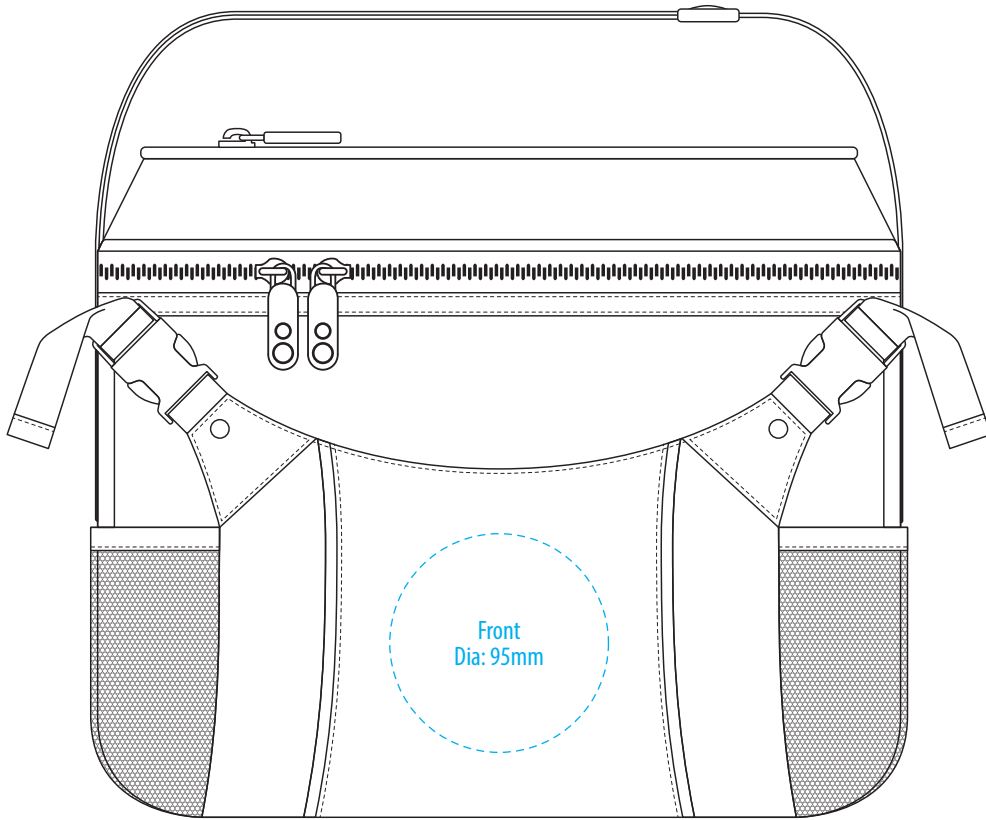

FRONT

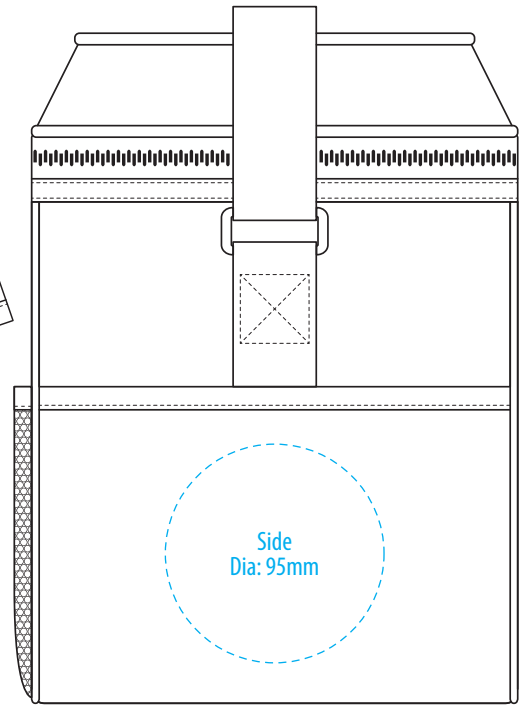

RIGHT SIDE

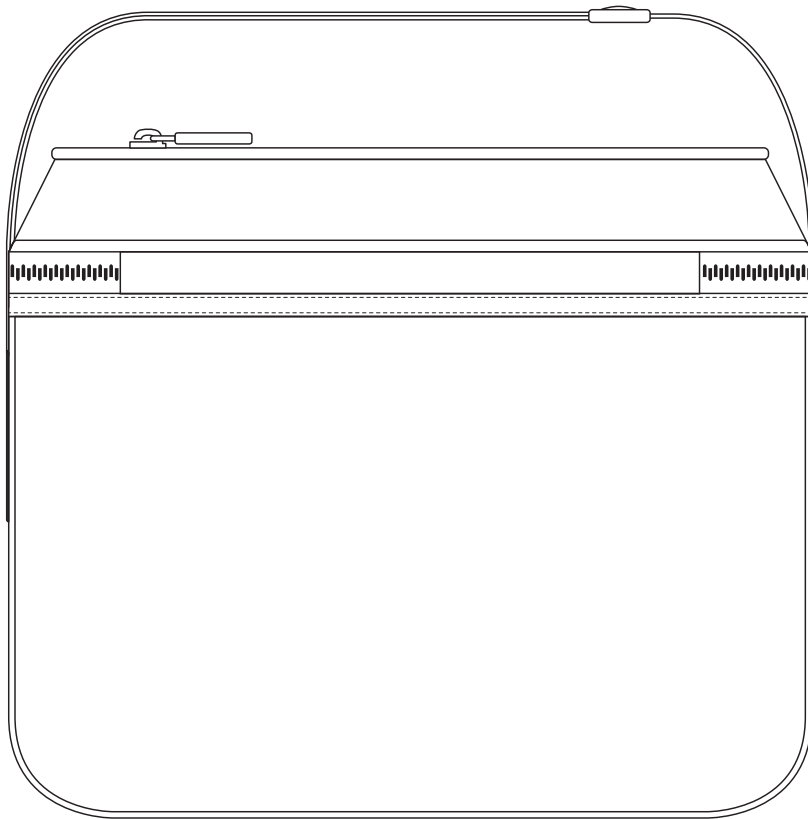

BACK

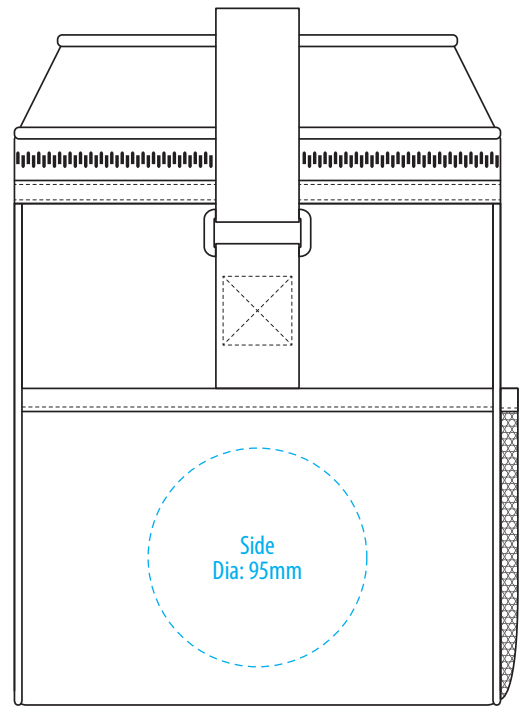

LEFT SIDE

NOTE:

The maximum decoration area is a guide only and is greatly dependant on the logo shape.

EMBROIDERY / SUPASUB / SUPAETCH / SUPAFLEX

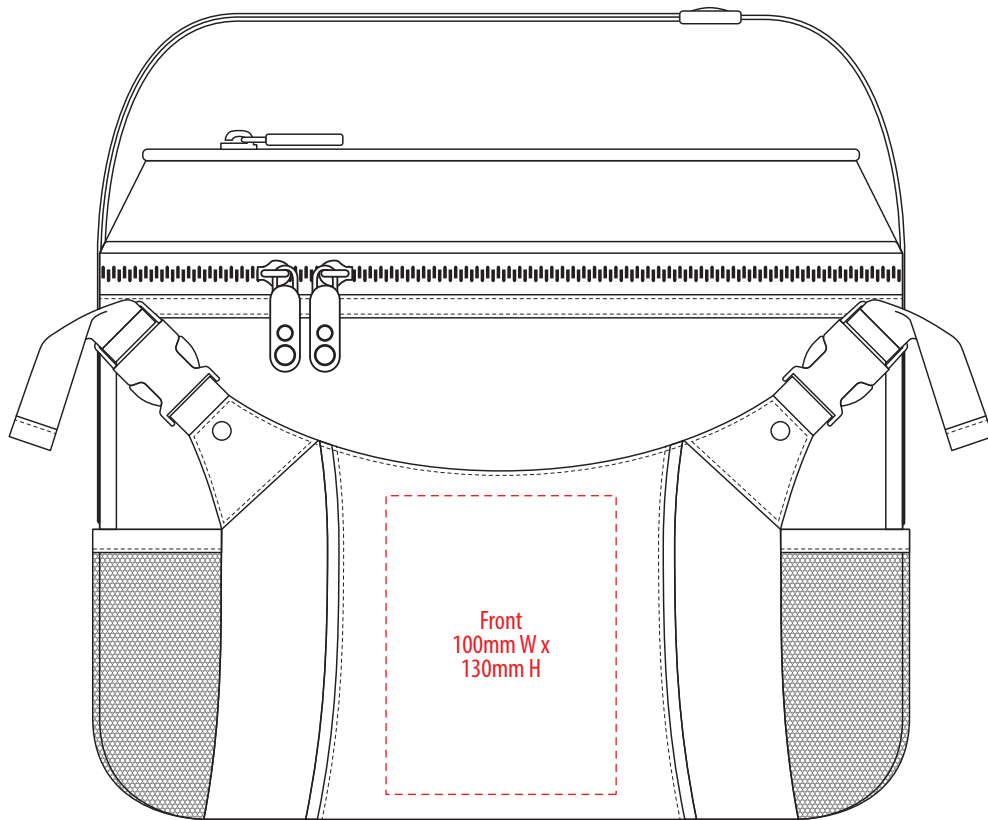

FRONT

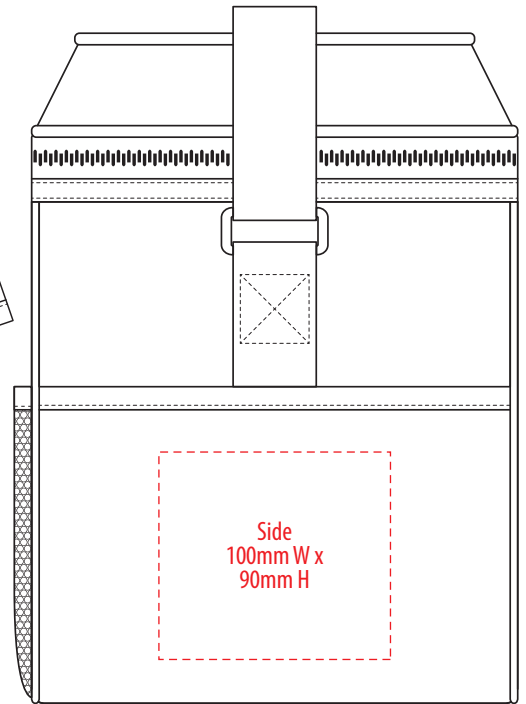

RIGHT SIDE

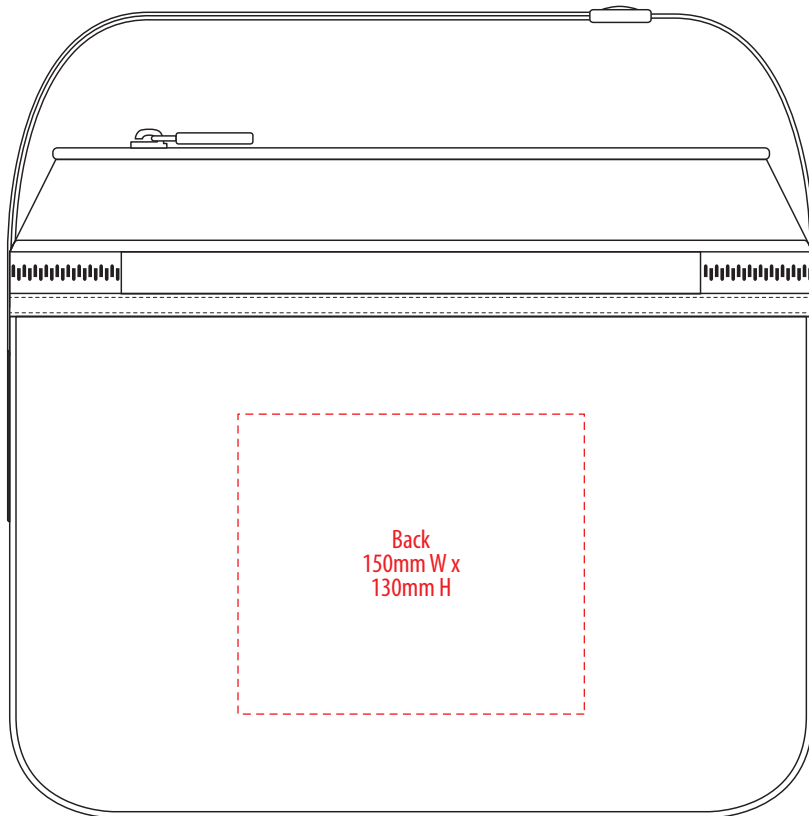

BACK

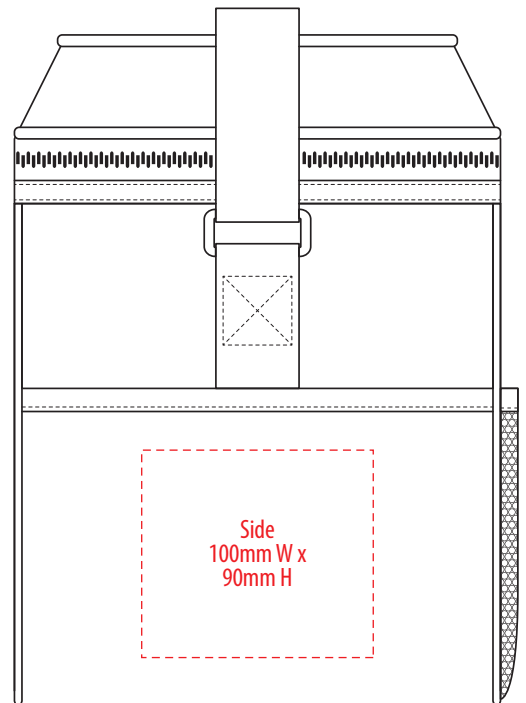

LEFT SIDE

NOTE:

The maximum decoration area is a guide only and is greatly dependant on the logo shape.

1061

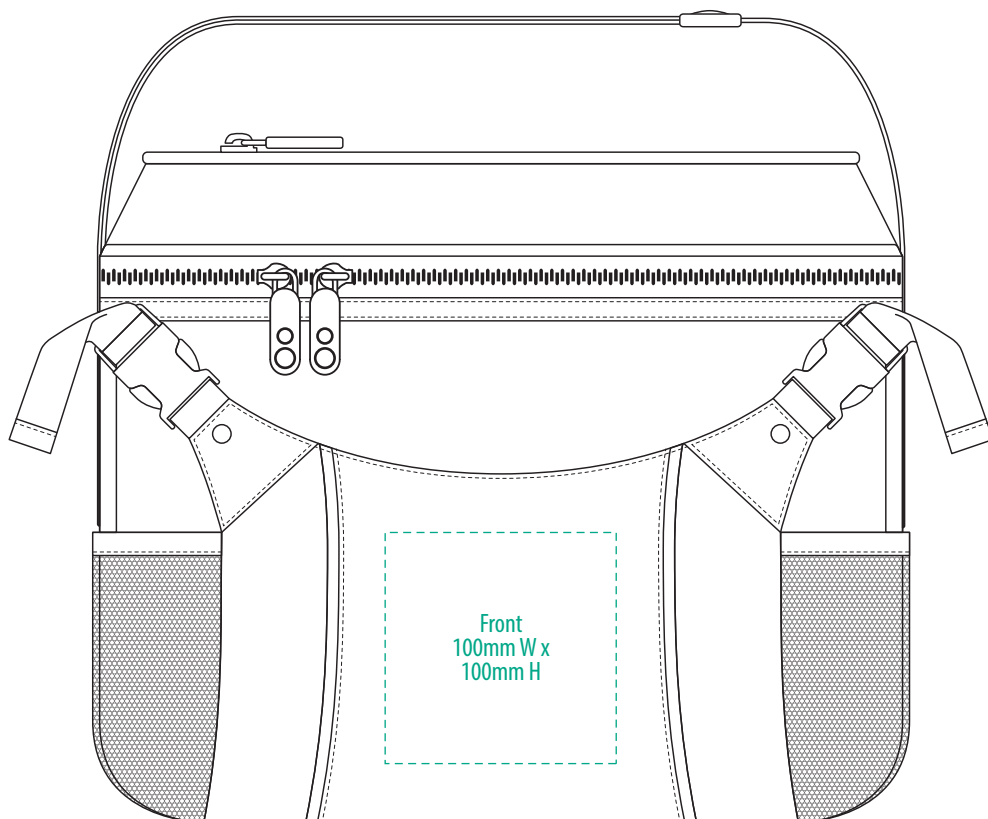

FRONT

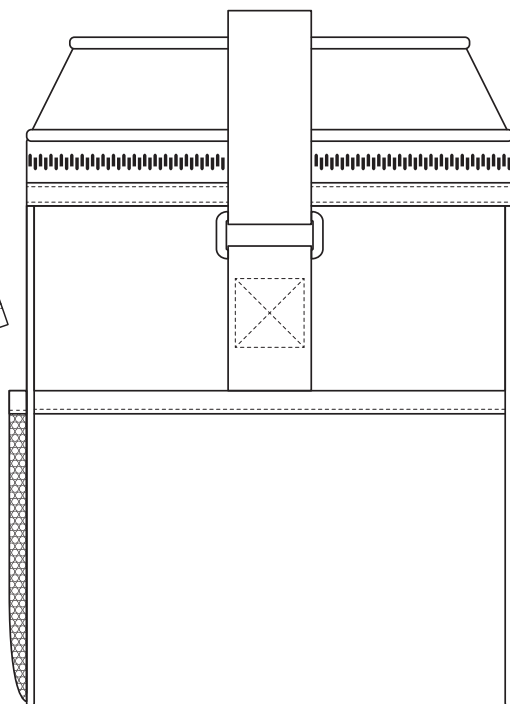

RIGHT SIDE

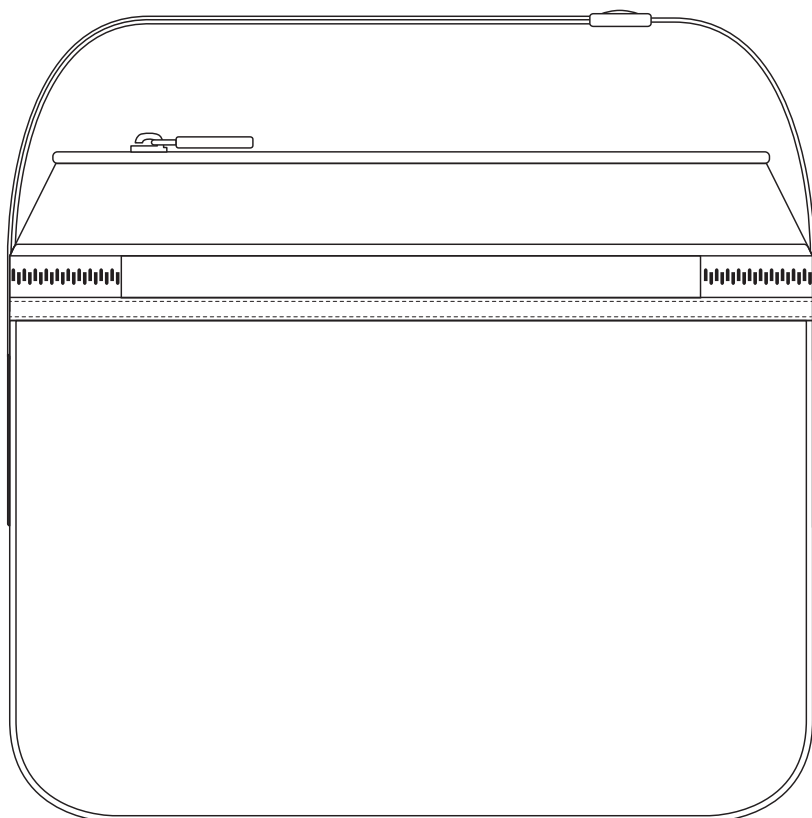

BACK

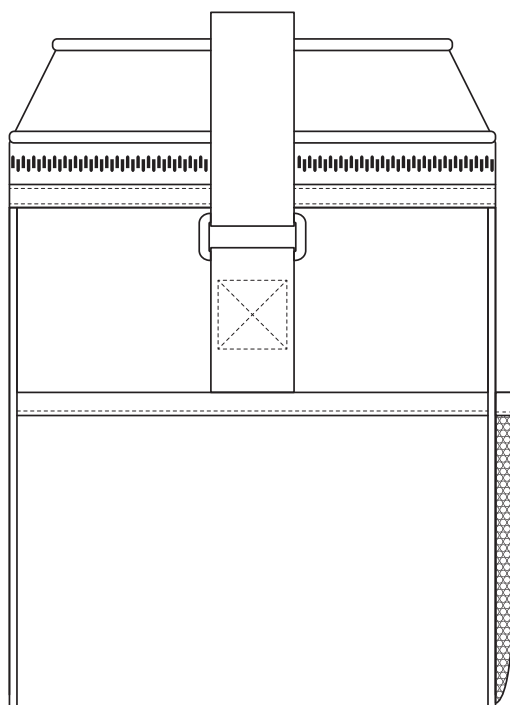

LEFT SIDE











NOTE:

The maximum decoration area is a guide only and is greatly dependant on the logo shape.

PRINT

1061

FABRIC SWATCH

BLACK/ORANGE		BLACK		PMS 165 C
BLACK/RED		BLACK		PMS 186 C
BLACK/SILVER		BLACK		PMS Cool Grey 3 C
BLACK/BLACK		BLACK		BLACK
BLACK/ROYAL		BLACK		PMS 286 C

Pantone colours are provided as a reference only and are based on closest match. Actual product colour may differ. If a precise colour match is required we recommend ordering a sample.