

4362

COLOURWAYS

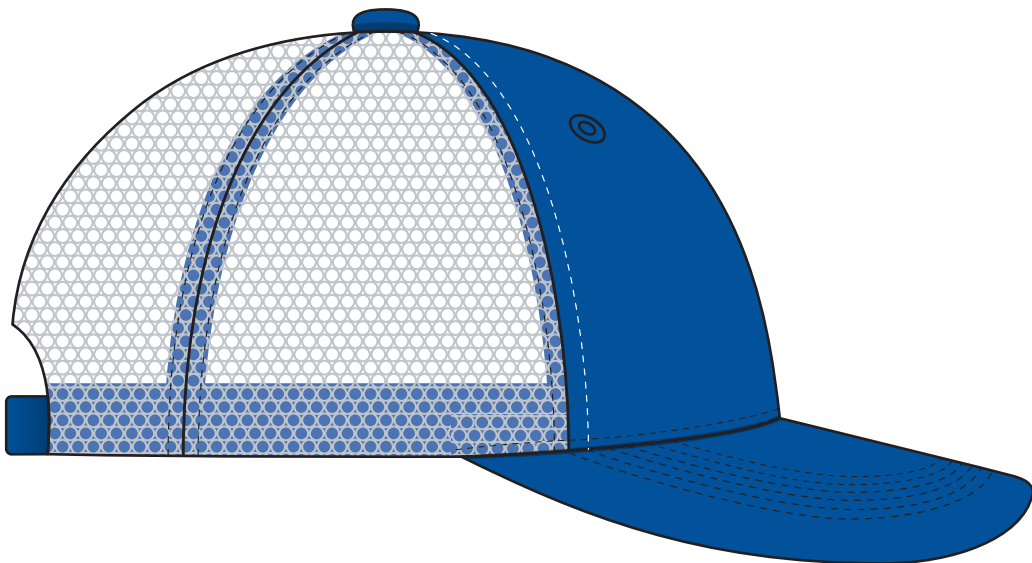
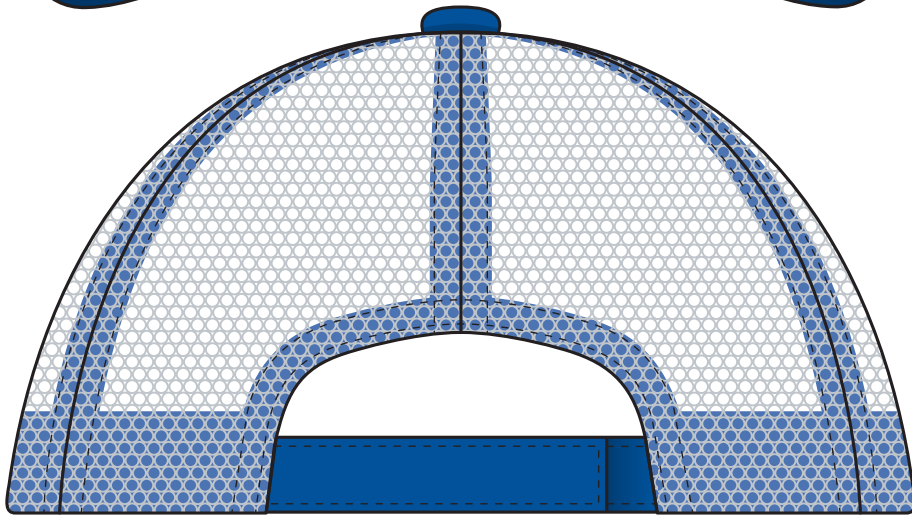

COLOUR

4362

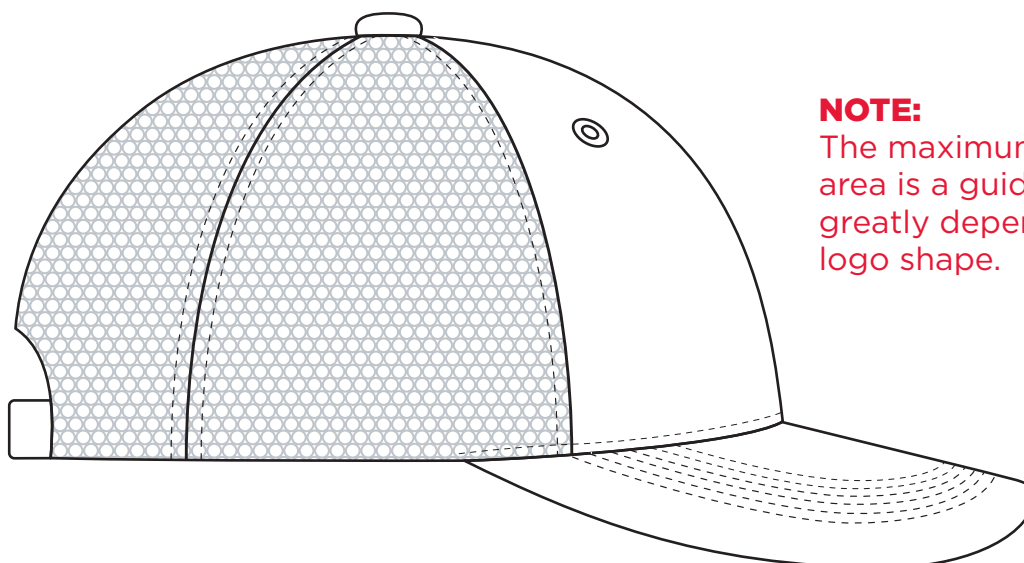
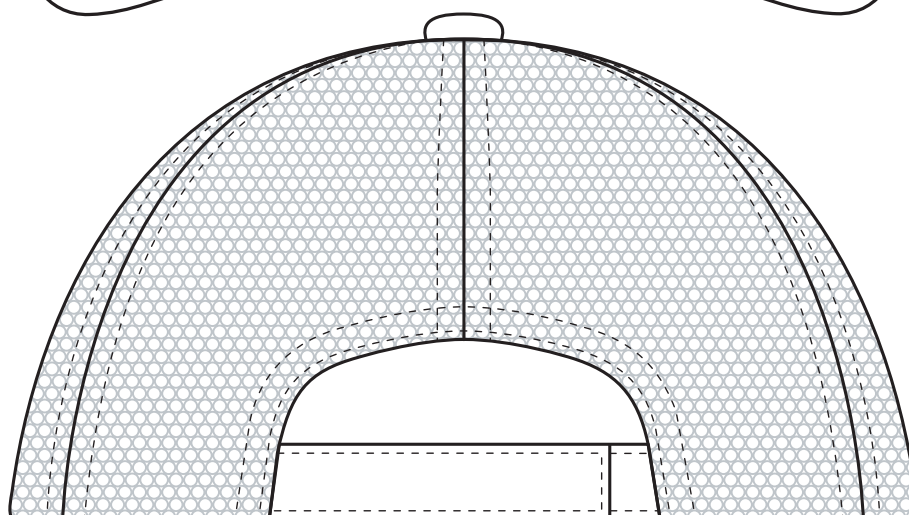
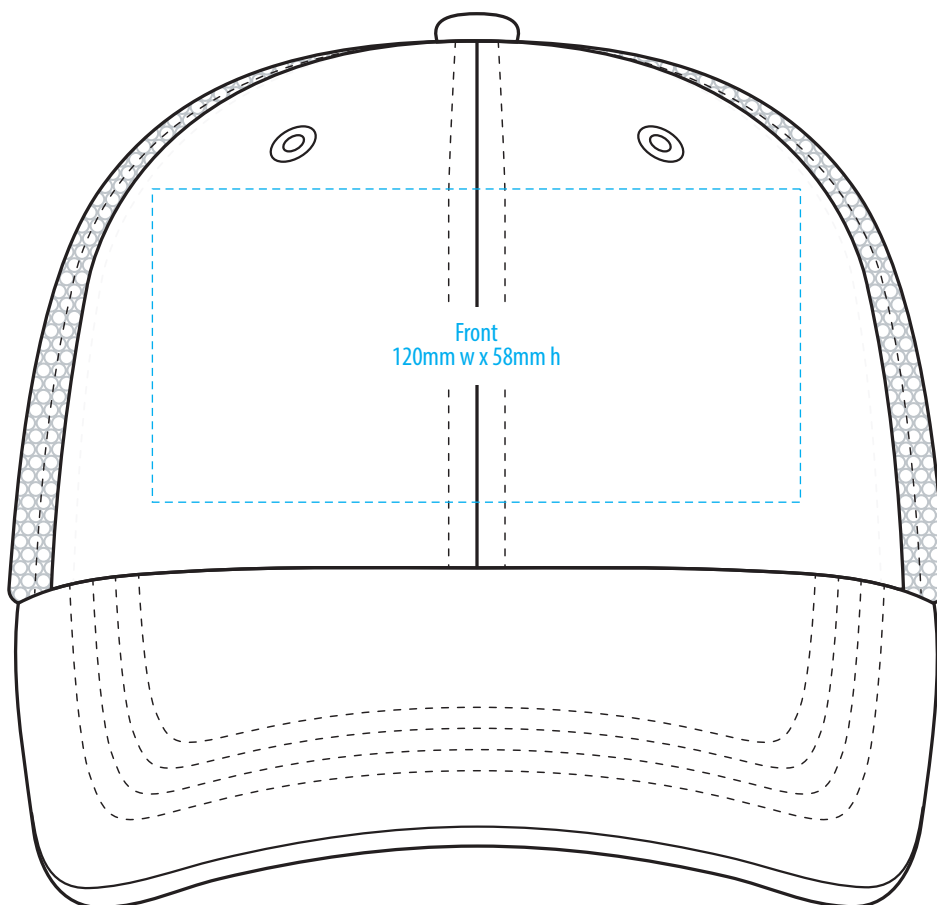

NOTE:
The maximum decoration area is a guide only and is greatly dependant on the logo shape.

EMBROIDERY

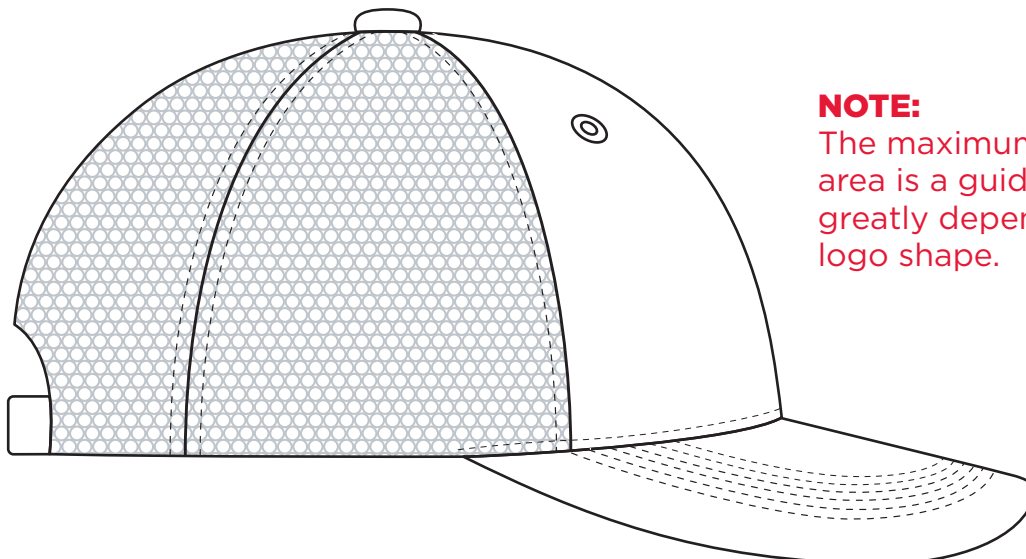
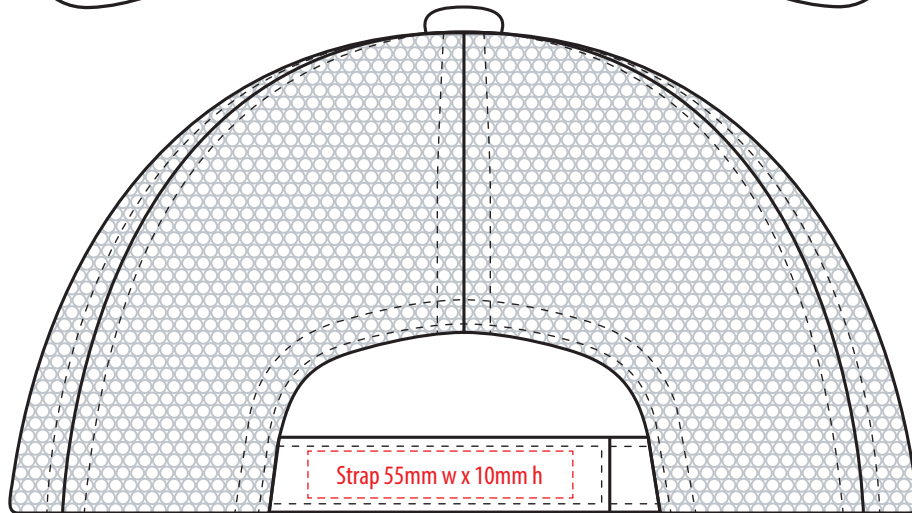
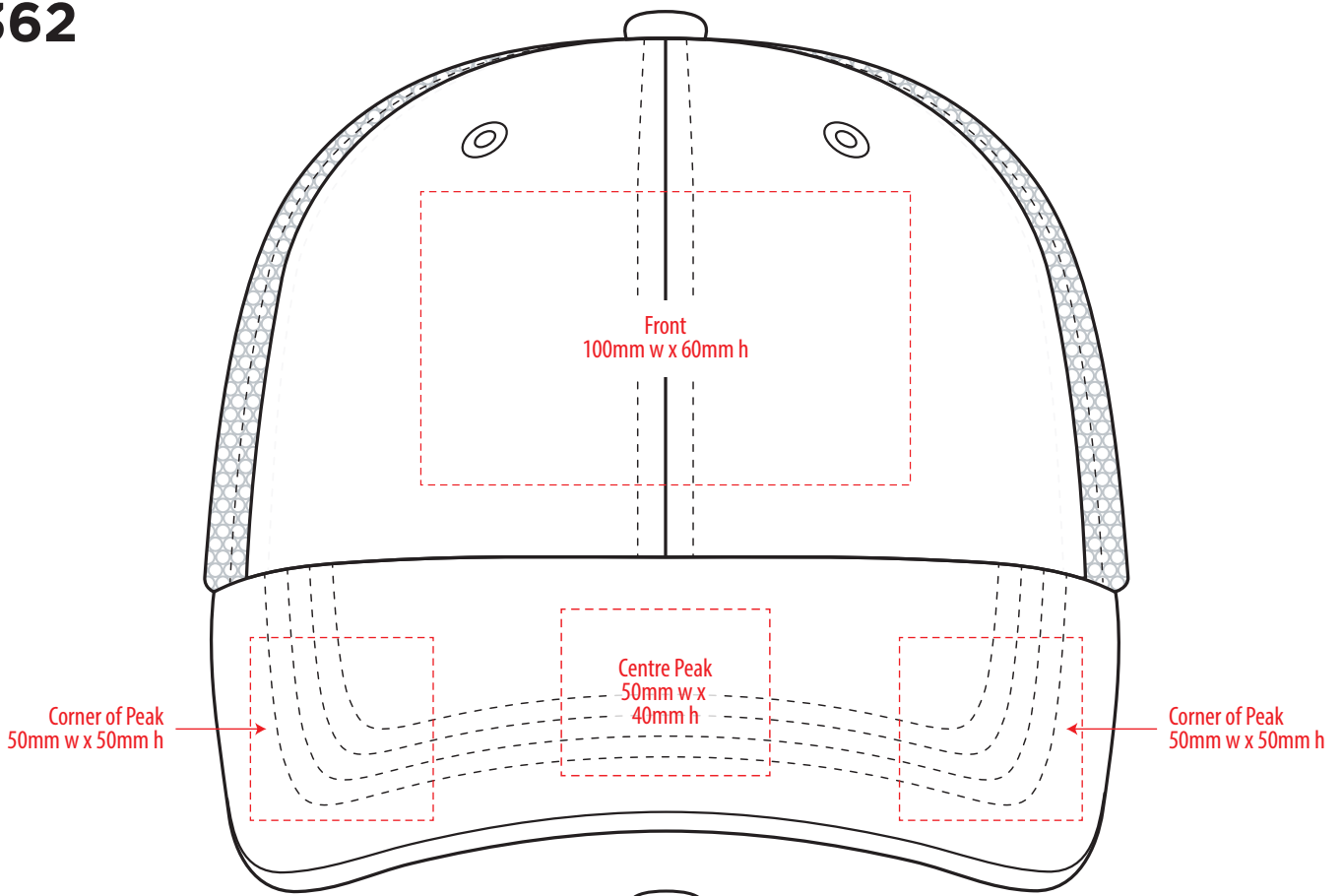

NOTE:
The maximum decoration area is a guide only and is greatly dependant on the logo shape.

4362

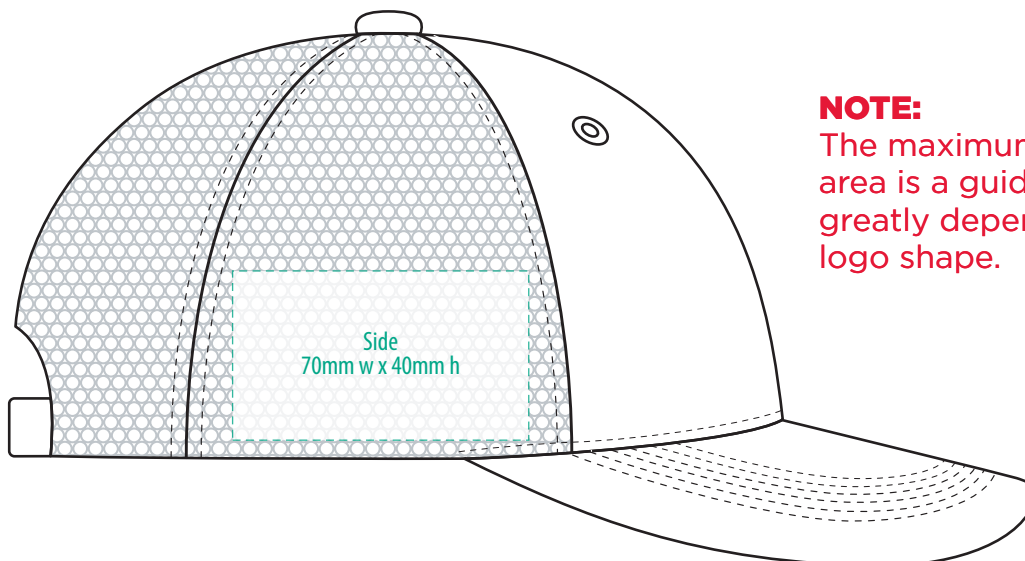
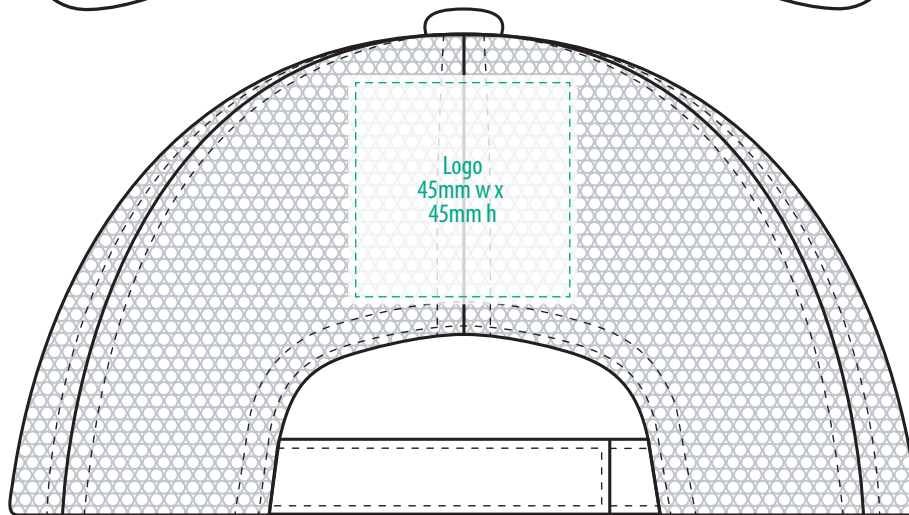
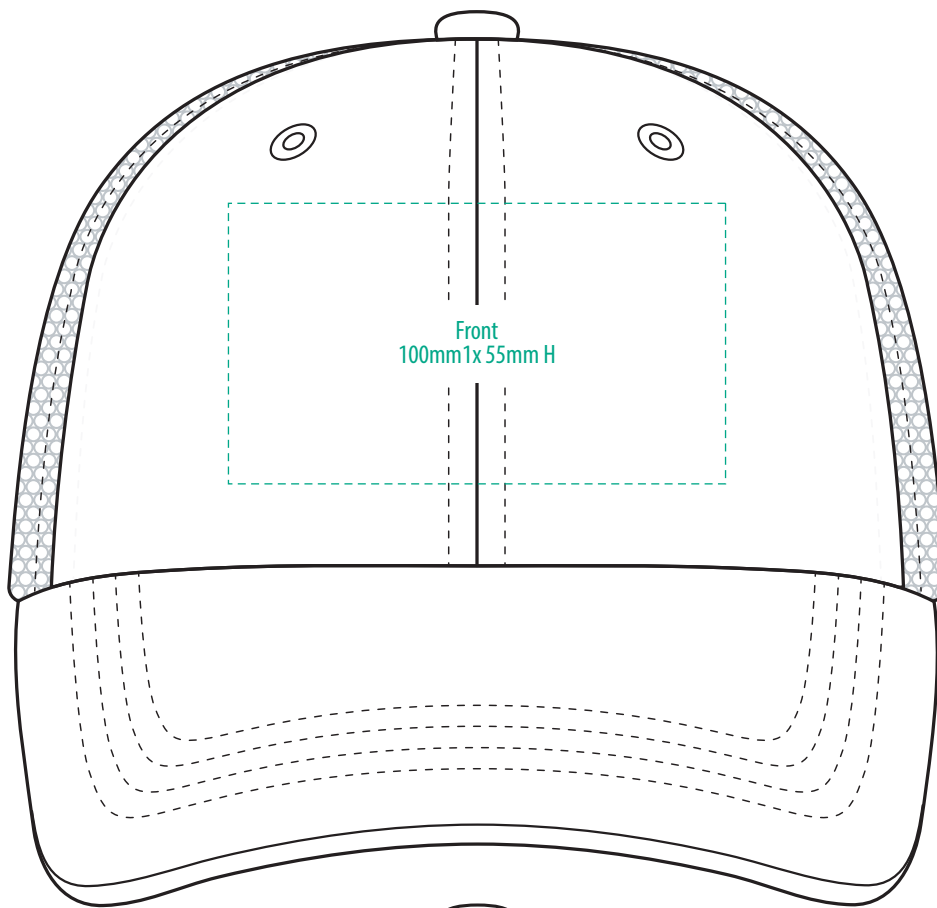









NOTE:
The maximum decoration area is a guide only and is greatly dependant on the logo shape.

SUPASUB / SUPAETCH / SUPAFLEX

[PATCH MUST BE AT LEAST 25MM X 25MM]

4362

FABRIC SWATCH

BLACK/CHARCOAL		BLACK		PMS Cool Grey 10 C
NAVY/SILVER		PMS 2965 C		PMS Cool Grey 5 C
RED/CHARCOAL		PMS 186 C		PMS Cool Grey 10 C
ROYAL/SILVER		PMS 287 C		PMS Cool Grey 5 C

Pantone colours are provided as a reference only and are based on closest match. Actual product colour may differ. If a precise colour match is required we recommend ordering a sample.