

8003

COLOURWAYS

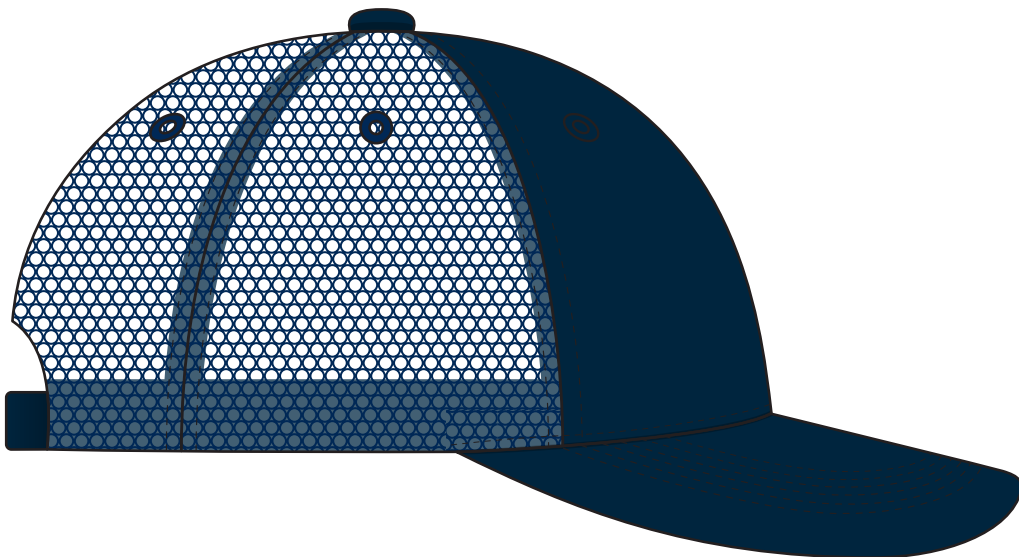
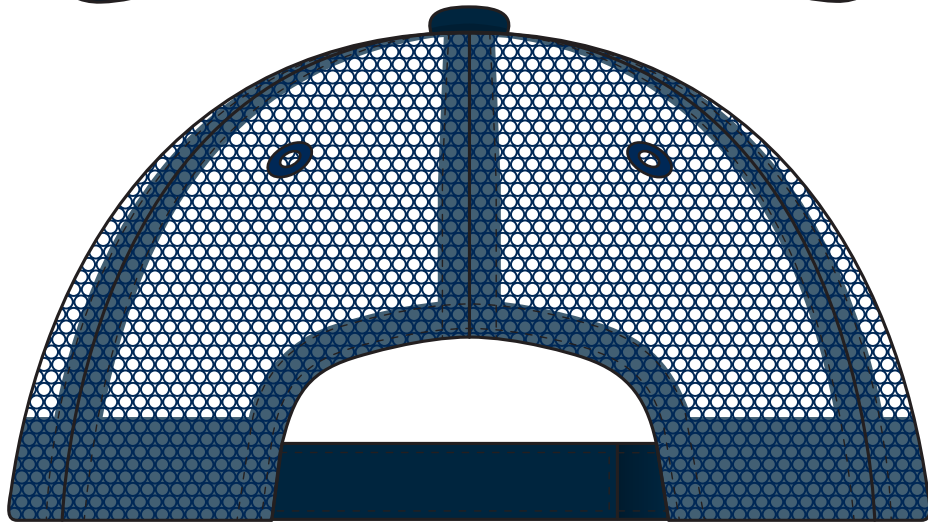
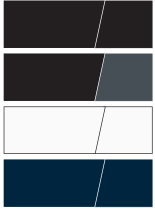

-----  
COLOUR

8003

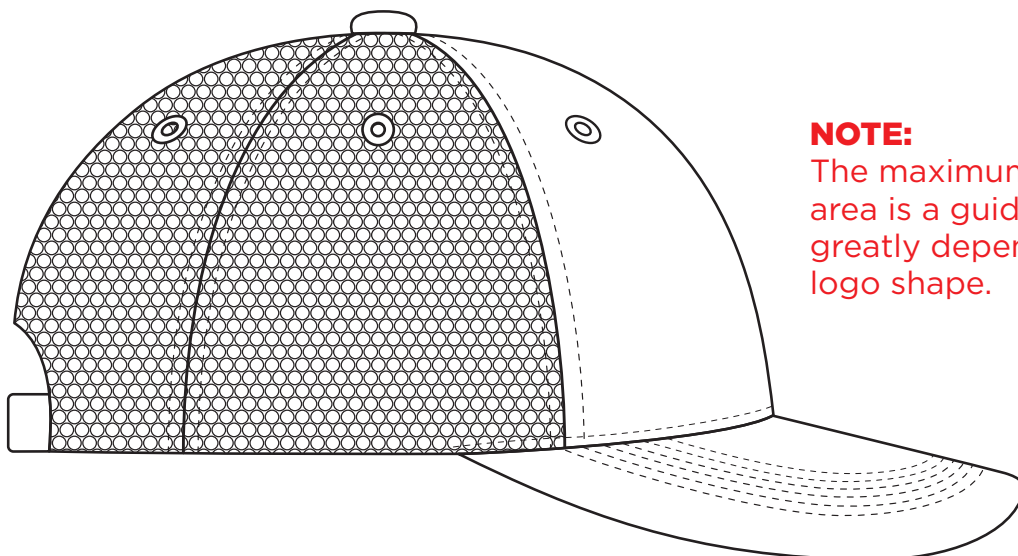
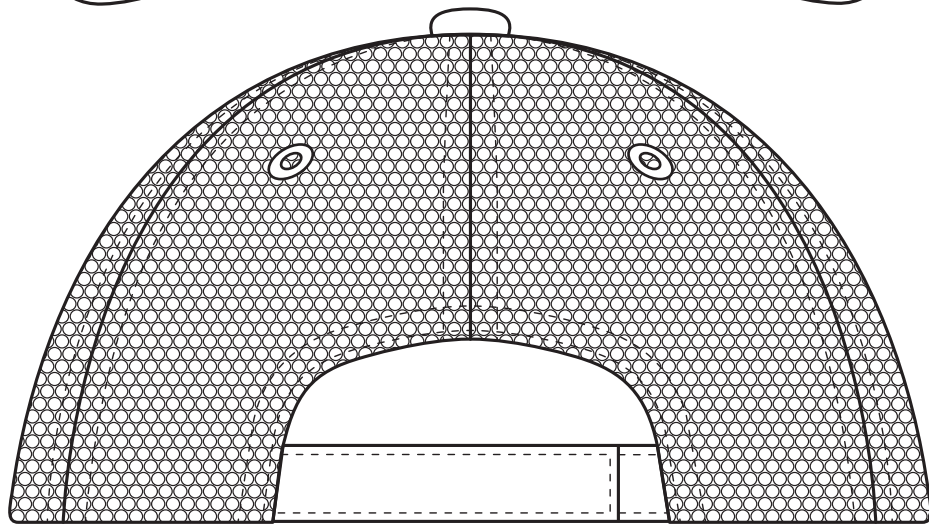
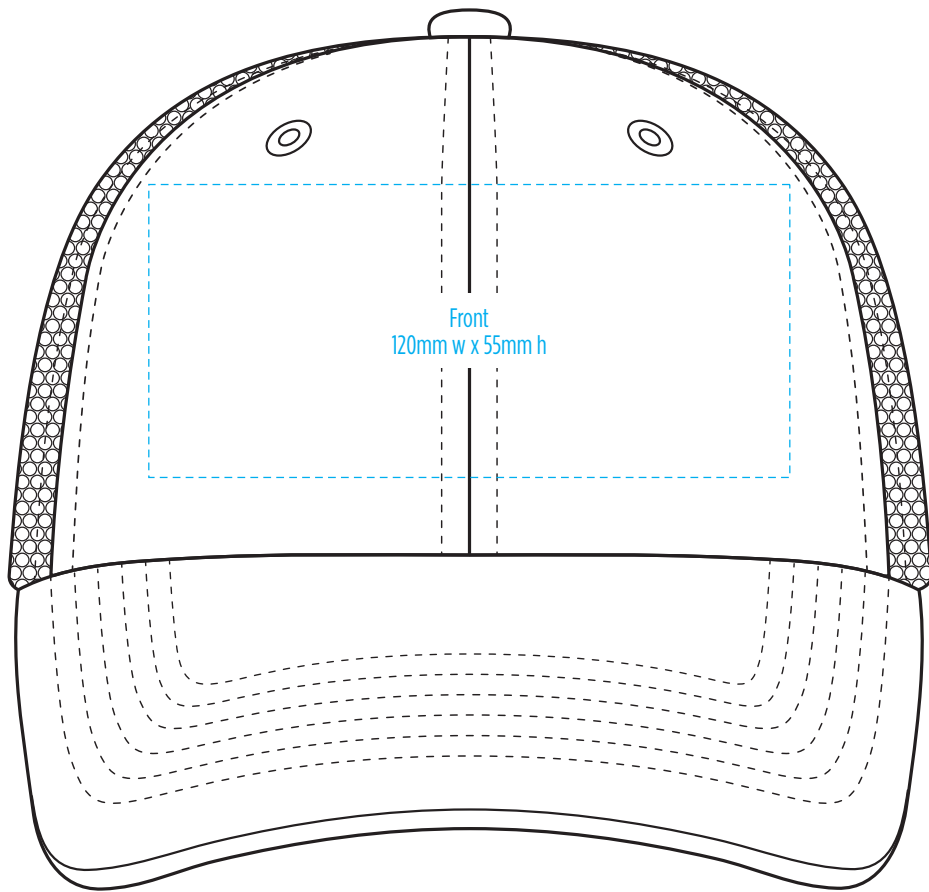

**NOTE:**  
The maximum decoration area is a guide only and is greatly dependant on the logo shape.

-----  
EMBROIDERY

8003

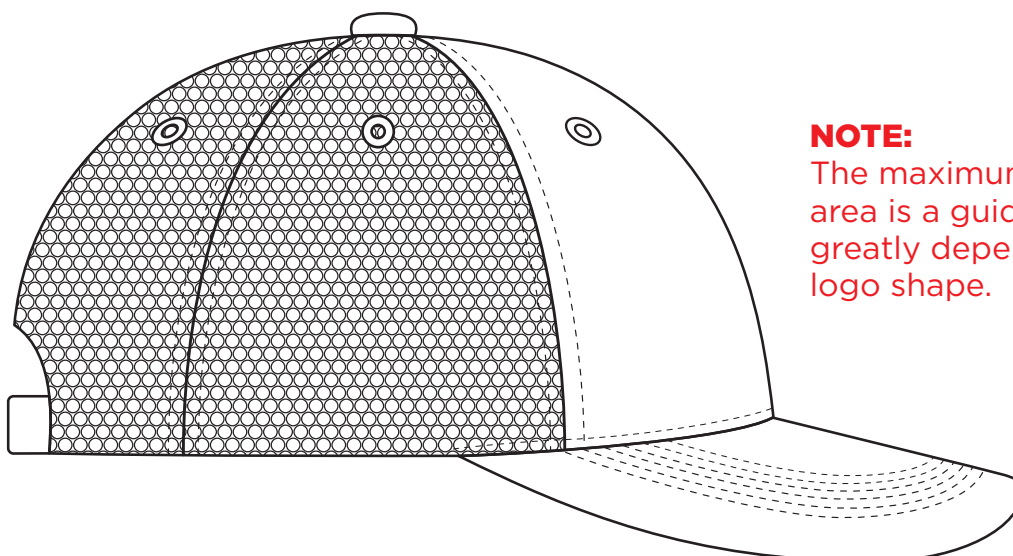
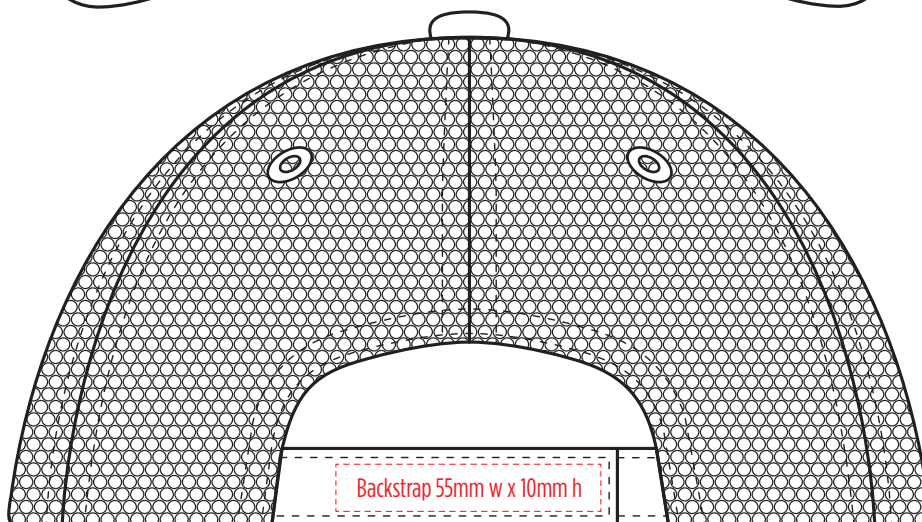
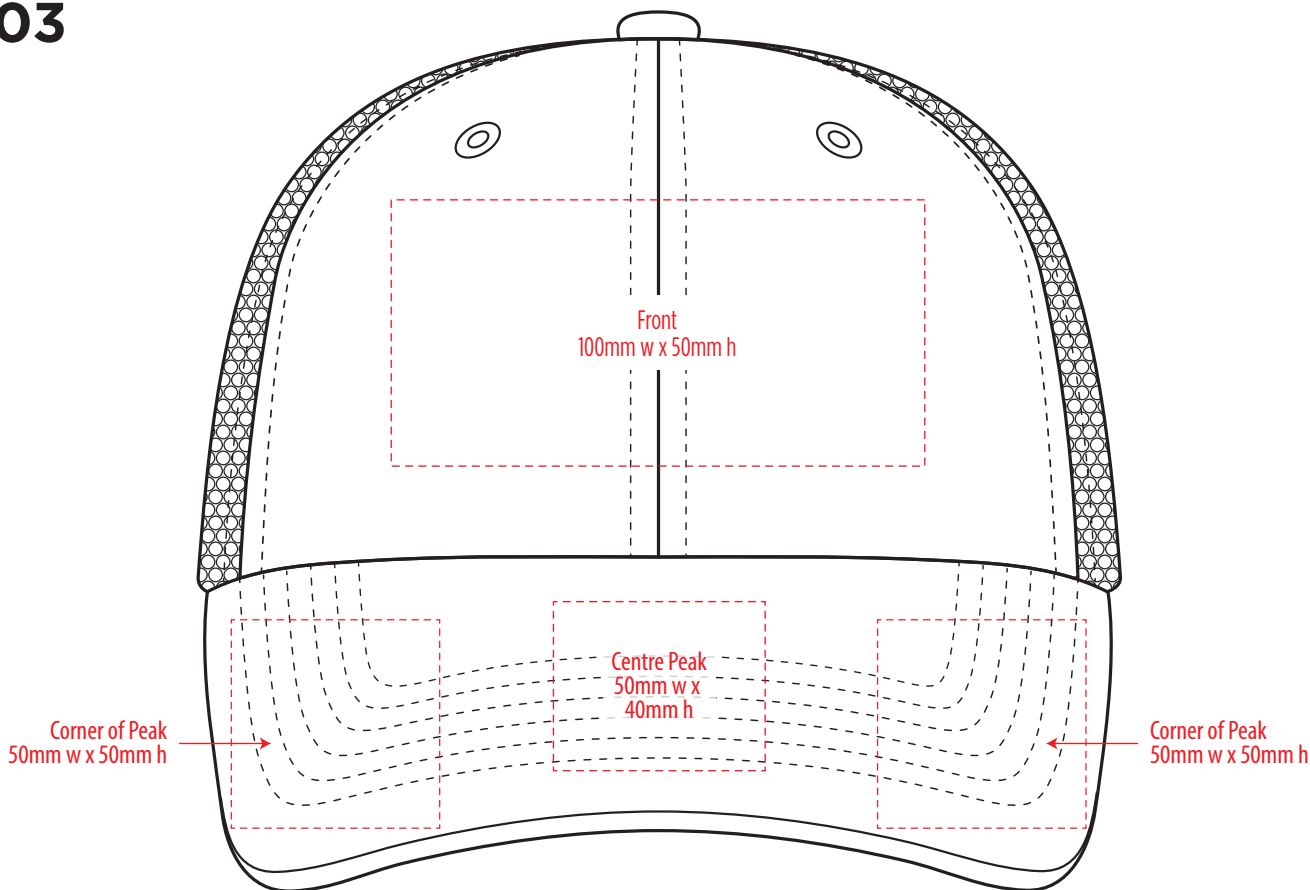

**NOTE:**  
The maximum decoration area is a guide only and is greatly dependant on the logo shape.

-----  
SUPACOLOUR

8003

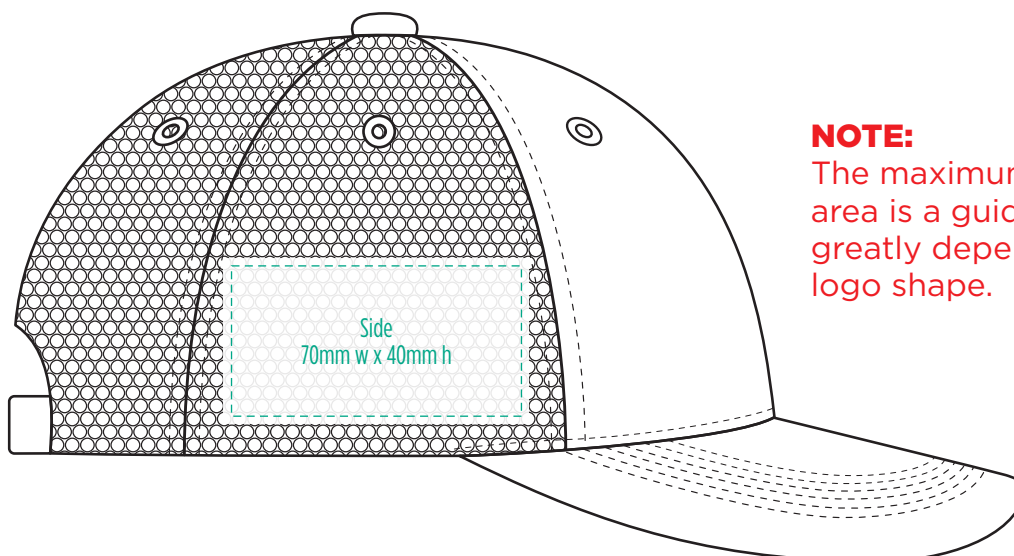
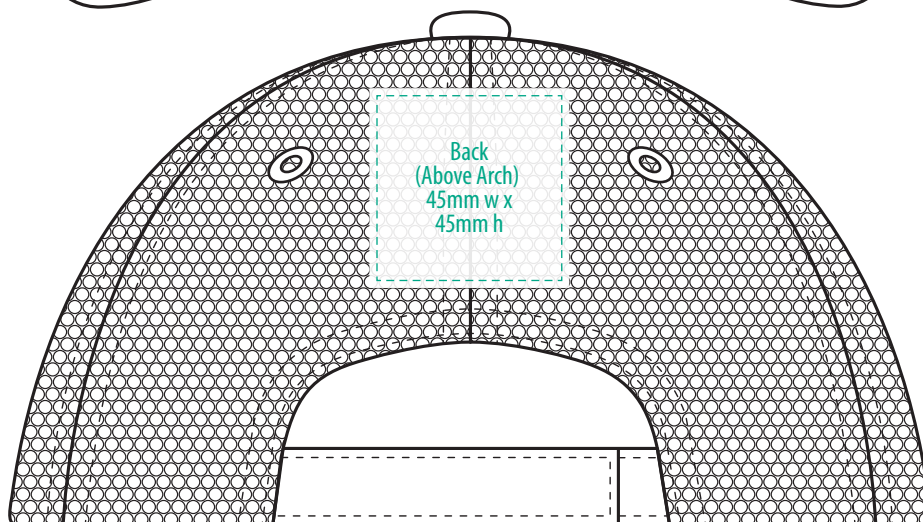
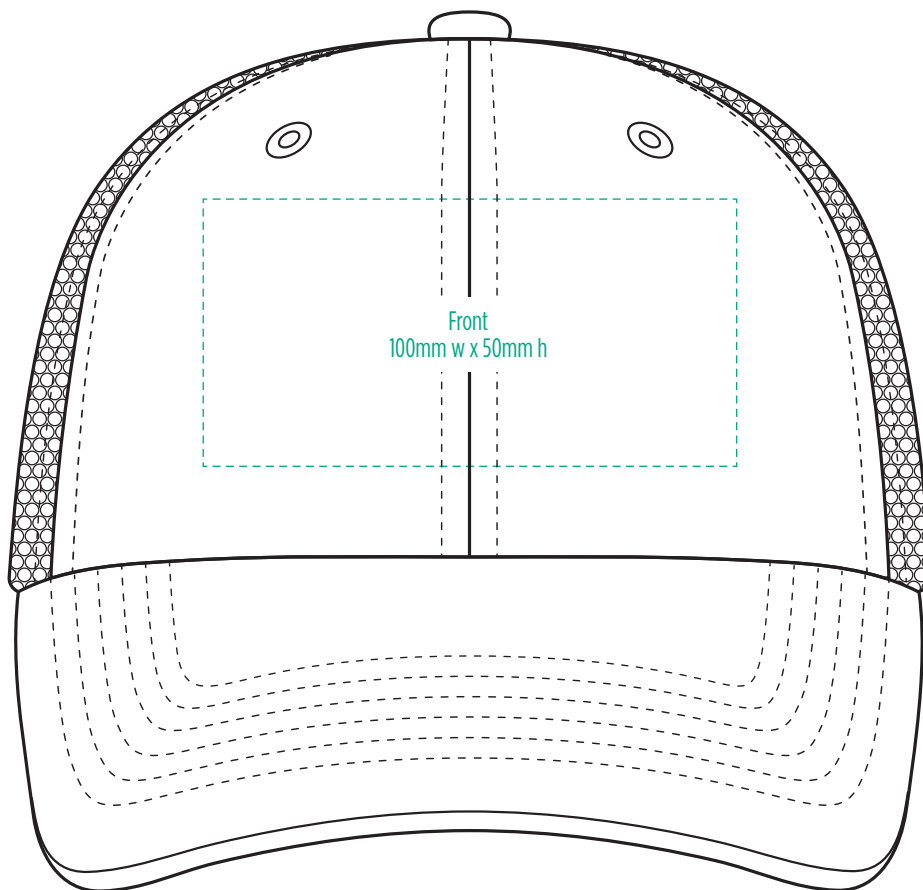

**NOTE:**









The maximum decoration area is a guide only and is greatly dependant on the logo shape.

SUPASUB / SUPAETCH / SUPAFLEX

[ PATCH MUST BE AT LEAST 25MM X 25MM ]

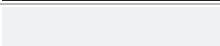
# 8003

# FABRIC SWATCH

<b>BLACK/BLACK</b>		BLACK		BLACK
<b>BLACK/CHARCOAL</b>		BLACK		PMS 7540 C
<b>CHK. WHITE/CHK. WHITE</b>		PMS Cool Grey 1 C		PMS Cool Grey 1 C
<b>NAVY/NAVY</b>		PMS 296 C		PMS 296 C

Pantone colours are provided as a reference only and are based on closest match. Actual product colour may differ. If a precise colour match is required we recommend ordering a sample.