

B282

COLOURWAYS



FRONT



BACK

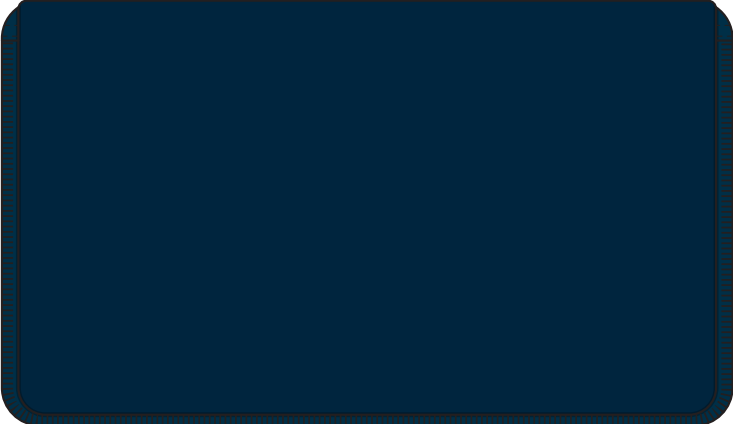

TOP

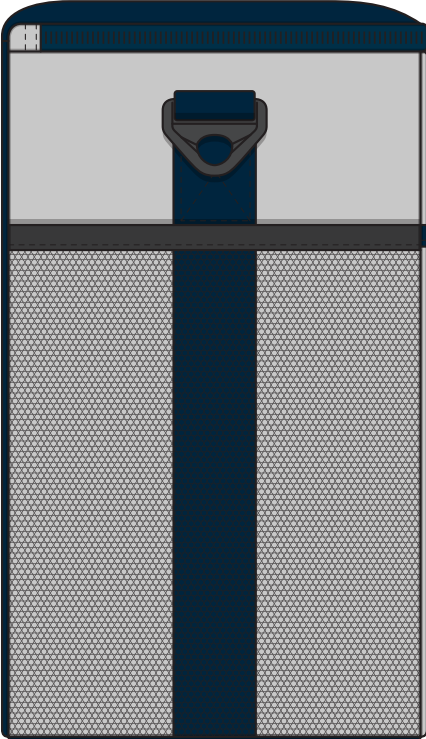

SIDE

COLOUR

B282

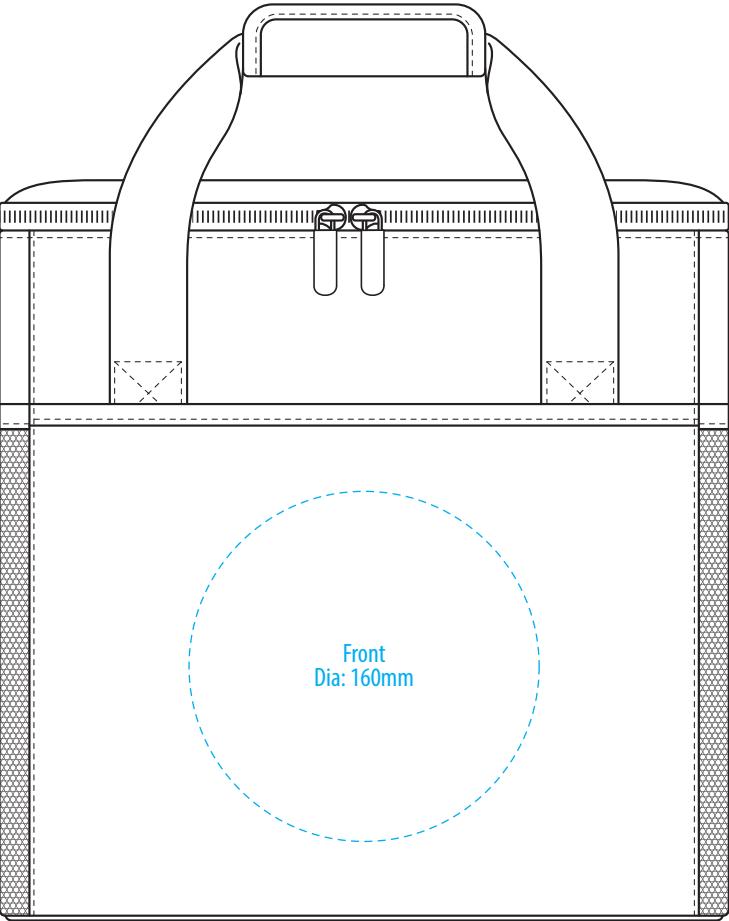

FRONT

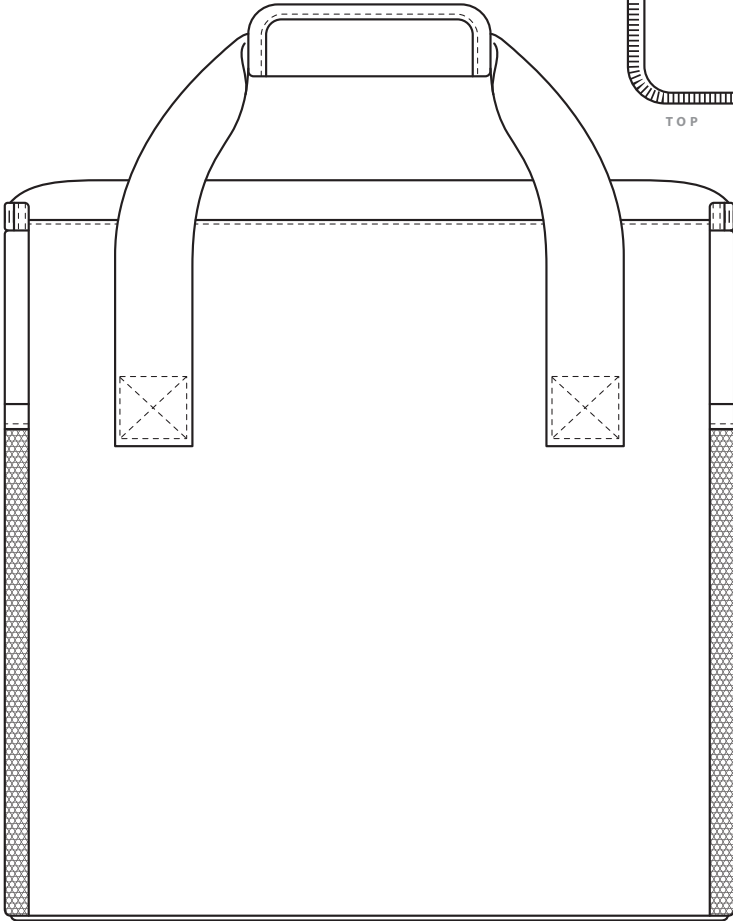

BACK



TOP

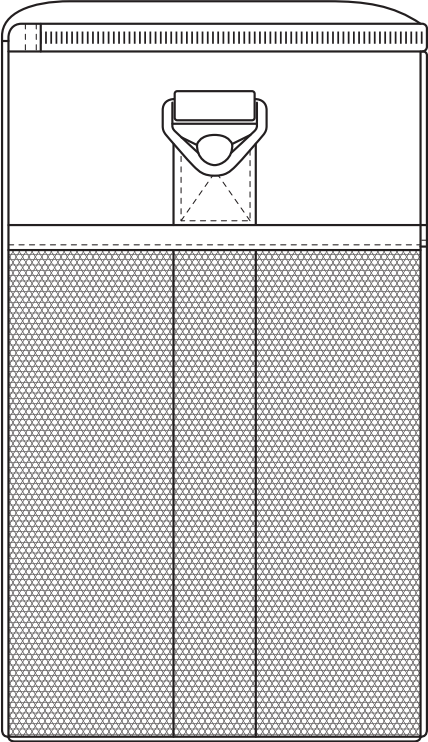

SIDE

NOTE: The maximum decoration area is a guide only and is greatly dependant on the logo shape.

EMBROIDERY

B282

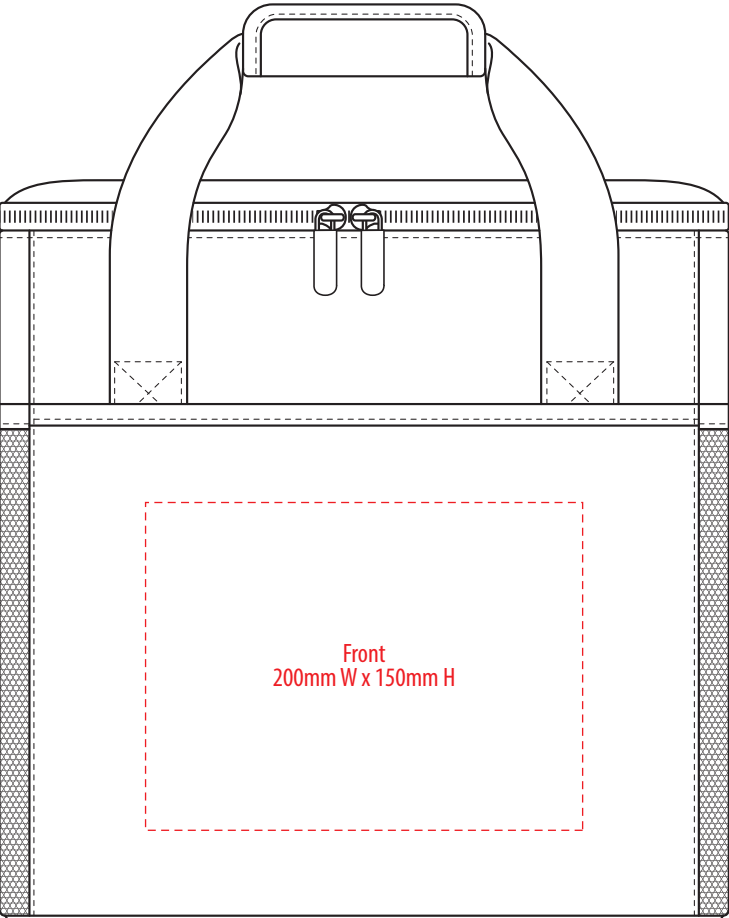

FRONT

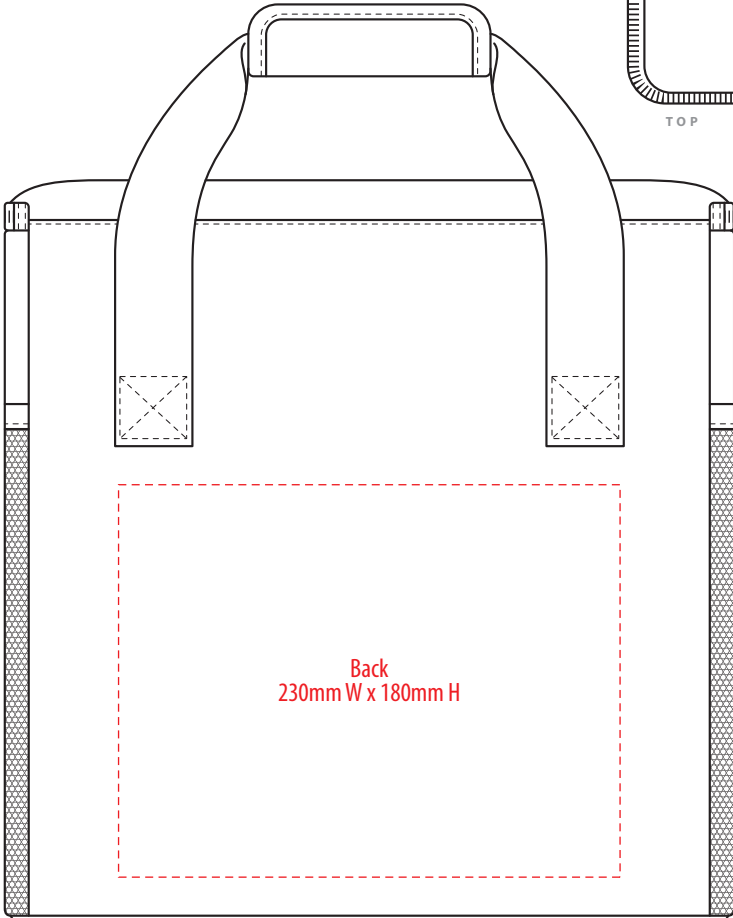

BACK

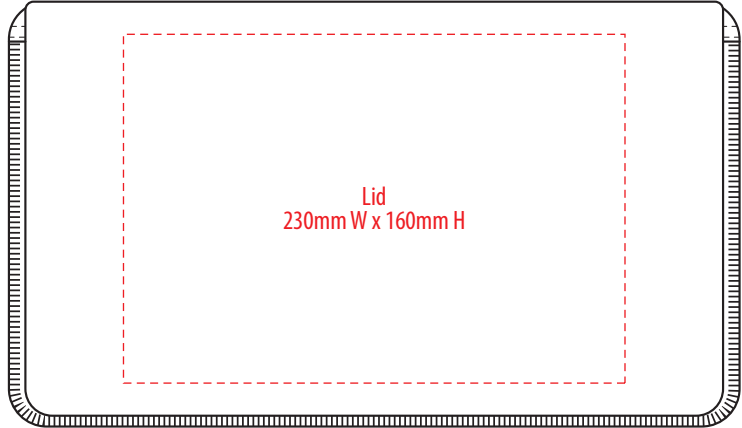

TOP

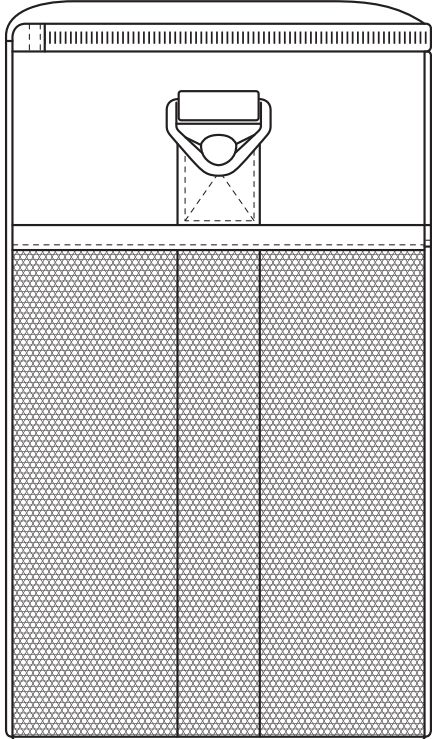

SIDE

NOTE: The maximum decoration area is a guide only and is greatly dependant on the logo shape.

SUPACOLOUR

B282

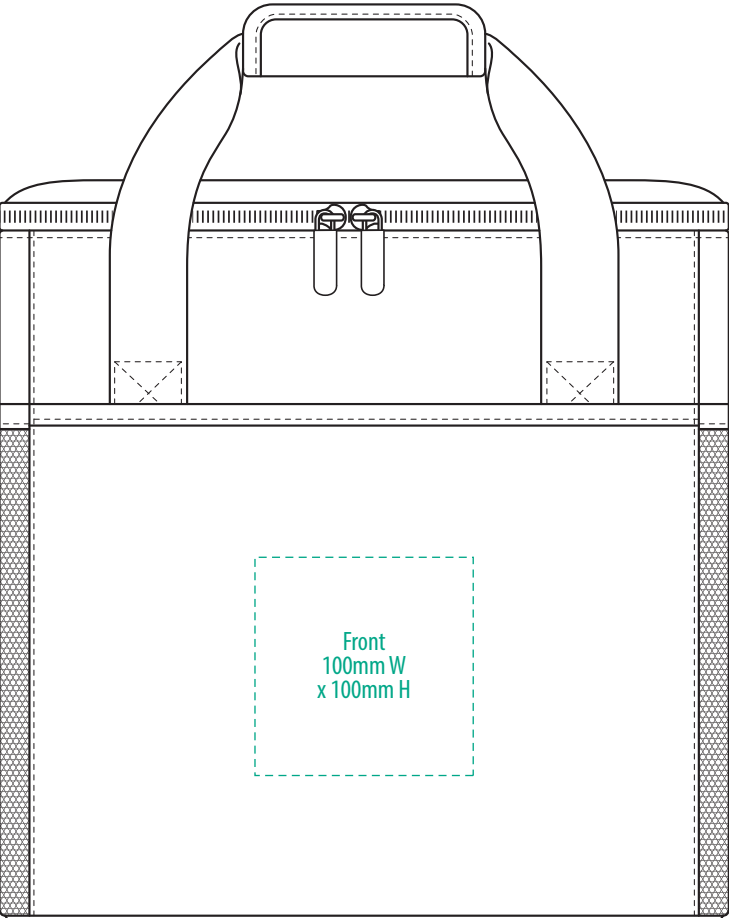

FRONT

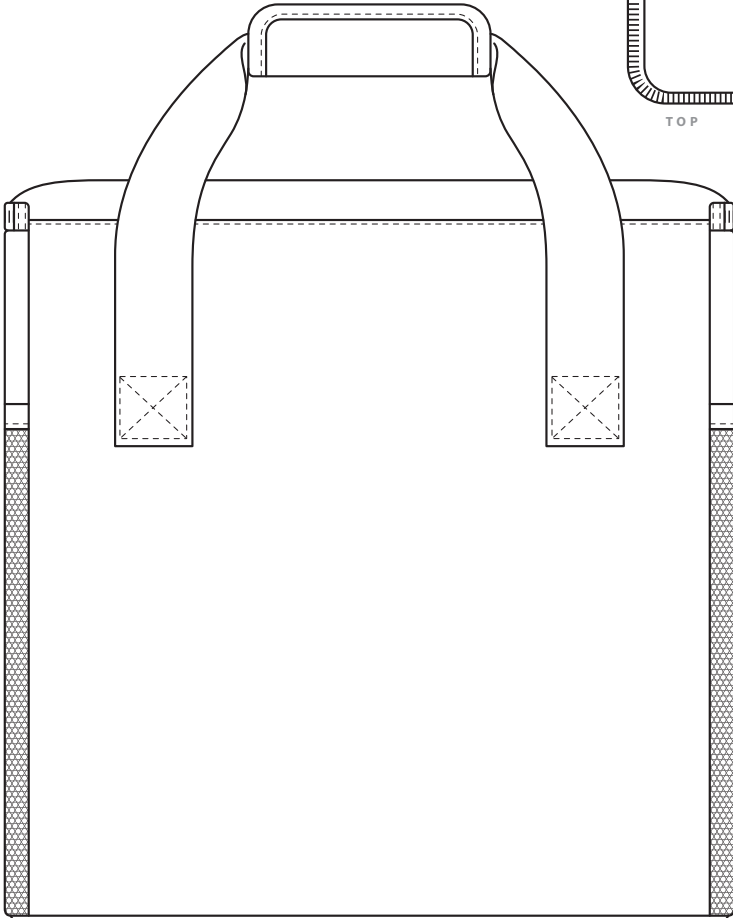

BACK



TOP

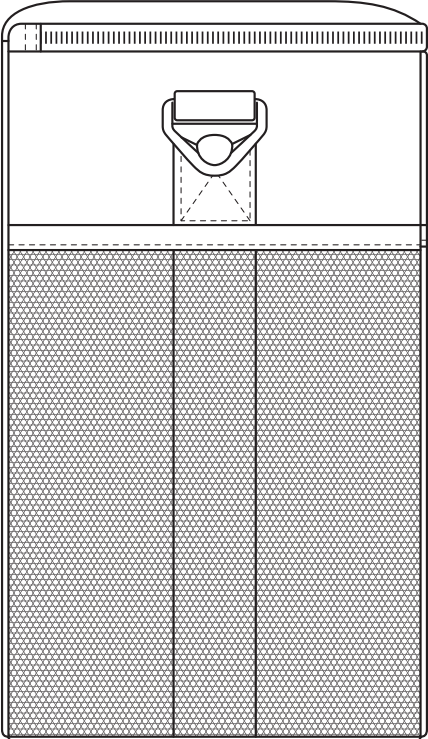

SIDE

NOTE: The maximum decoration area is a guide only and is greatly dependant on the logo shape.

SUPASUB / SUPAETCH / SUPAFLEX

B282

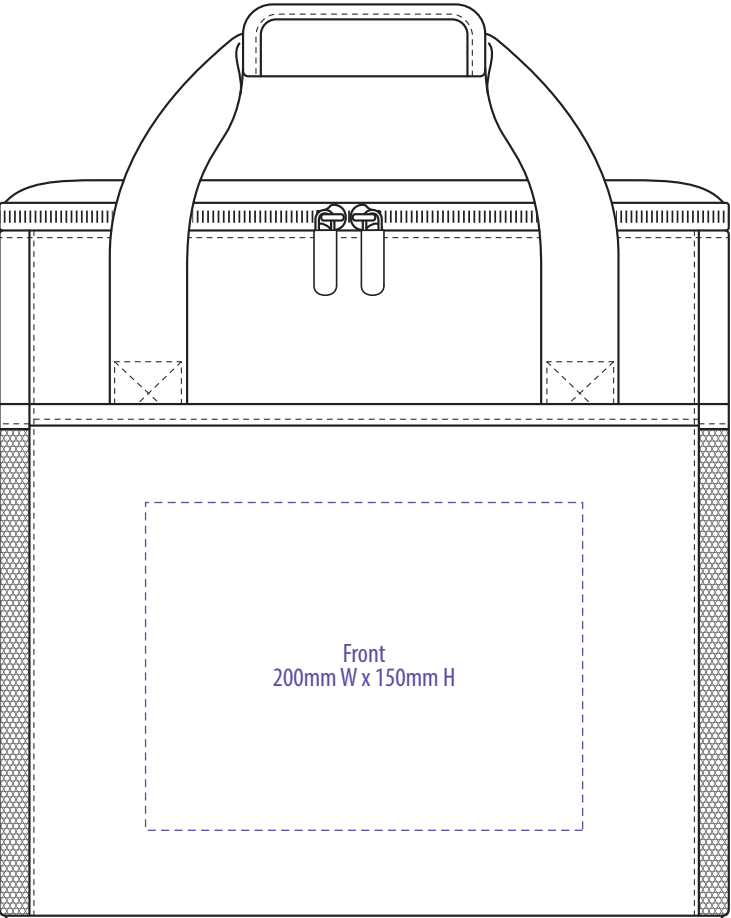

FRONT

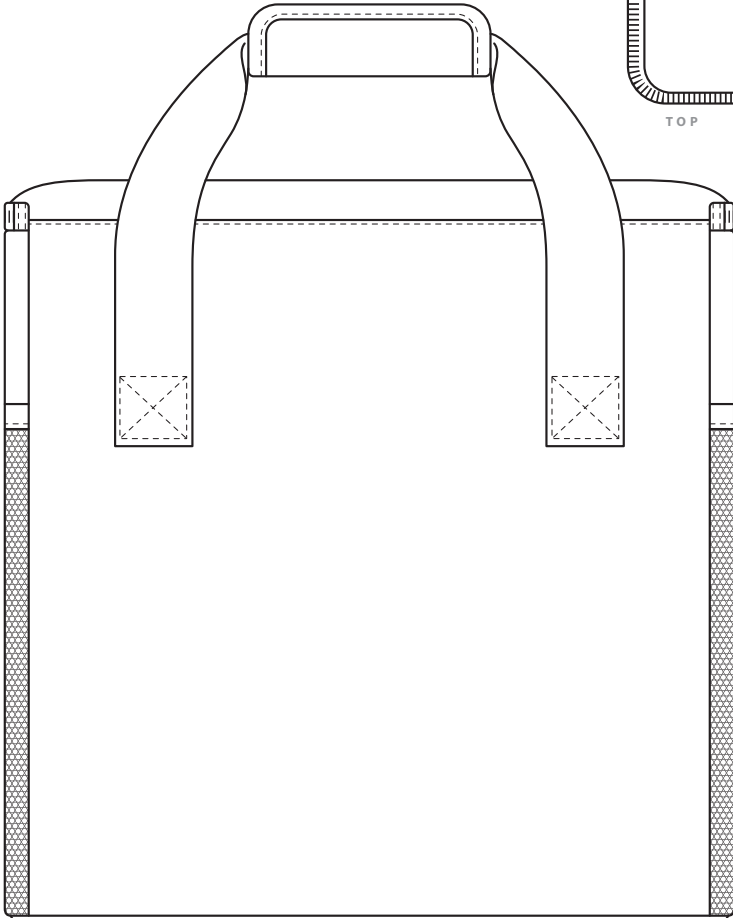

BACK

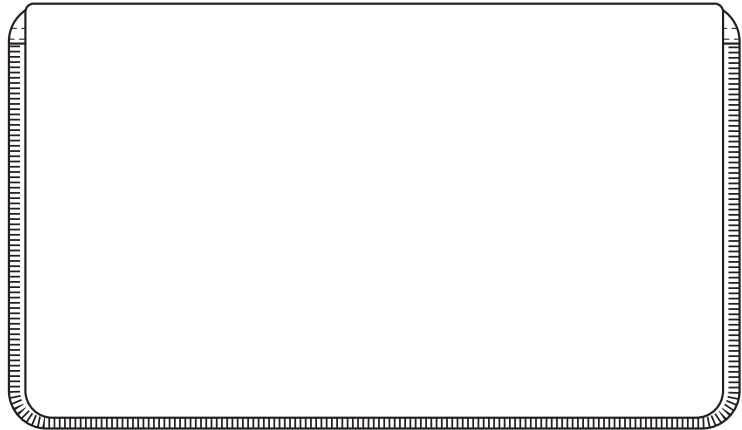

TOP

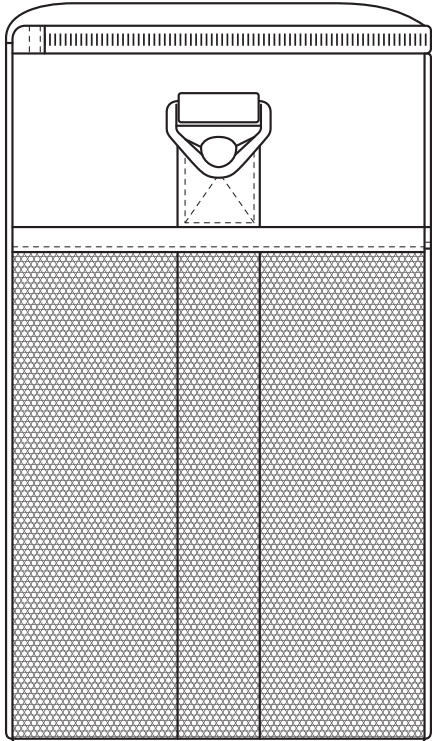







SIDE

NOTE: The maximum decoration area is a guide only and is greatly dependant on the logo shape.

SCREENPRINT

B282

FABRIC SWATCH

BLACK/CHARCOAL		BLACK		PMS 432 C
BLACK/RED		BLACK		PMS 186 C
NAVY/SILVER		PMS 2965 C		PMS Cool Grey 3 C

Pantone colours are provided as a reference only and are based on closest match. Actual product colour may differ. If a precise colour match is required we recommend ordering a sample.